

# morbidelli m600/m800

numerical controlled machining centres



# morbidelli m600/800

numerical controlled **machining centres**

## THE SOLUTION THAT COMBINES QUALITY AND TECHNOLOGY

Modular machining centres designed and developed to satisfy the requirements of furniture manufacturers.





# morbidelli m600/800

exclusive features



## **MACHINING EFFICIENCY: MACHINING HEADS THAT SLIDE ON TWO INDEPENDENT "Z" AXIS**

Maximum rapidity during machining changeover with minimized idle times thanks to the double independent "Z" axis on which the two machining heads slide. The possibility to customise the two heads considerably increases the tools available to the operator.

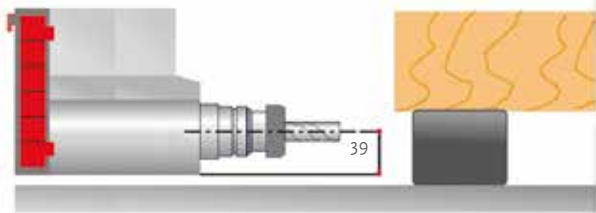

## **SUPERIOR TECHNOLOGY FOR MACHINING WITH 5 AXES: PRISMA ELECTROSPINDLE**

Reduced maintenance, maximum flexibility and optimal finishing quality with the BEL.TECH technology (Belt technology system), the belt transmission system which eliminates vibration and heat from tools to the motor. This system (in use on the spindle for machining metals) due to the compact structure, allows easy operations in limited spaces.



## **THE PERFECT DRILLING: RO.AX SPINDLE**

Zero play during machining with the new RO.AX technology (Rotoaxial spindle technology), the most efficient spindle on the market with rotation speeds up to 8000 rpm. The sturdiness of drilling heads is proven by the reduced maintenance costs: five times less than that imposed by the majority of other machine manufacturers.

**THE PERFECT COMBINATION  
OF SAFETY AND PRODUCTIVITY:  
PHOTO-BUMPERS**

High production capacity and greater freedom of movement also during alternated work process due to the safety system that brings together the bumpers devices with the photocells for the detection of the operator's position inside the loading/unloading area.

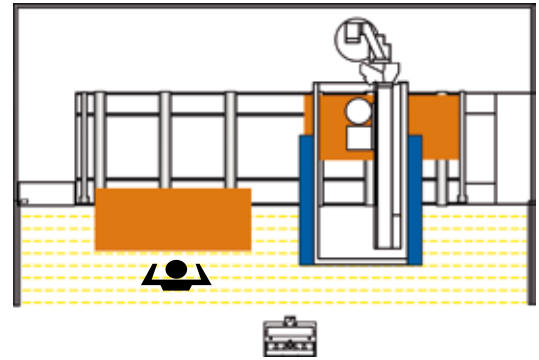

**TOTAL LACK OF VIBRATIONS:  
MOBILE GANTRY STRUCTURE**

Performance without comparison with the mobile gantry structure that allows for high machining speeds whilst guaranteeing the best end products quality.



**UNIQUE CREATIVITY:  
MAESTRO CNC**

CAD/CAM programming software to design all the production processes. Developed in Windows® environment it ensures easy programming with an advanced, simple and intuitive sketching environment that features all the tools necessary to design the parts, their layout on the work table, tools management and the relative machining operations. All the procedures are contained in a perfectly integrated and high performance software.



# morbidelli m600/800

machining unit: **routing unit**

Vertical, horizontal, tilting machining and large dimensioned cuts with blade with 3-4-5 axes routing units up to 17 kW motor power.

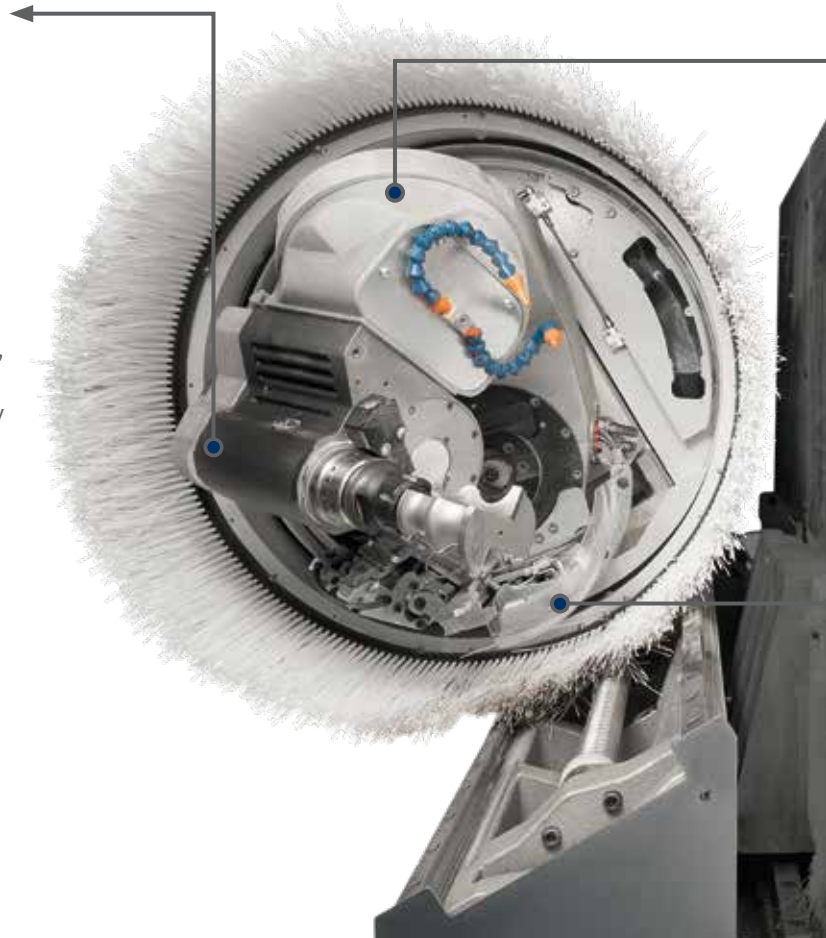

## POWERFUL AND RELIABLE

Ease-of-use and flexibility with the 5-axes machining unit, unique in its category in terms of performance. Wide range of specific electrospindles to carry out any type of machining.

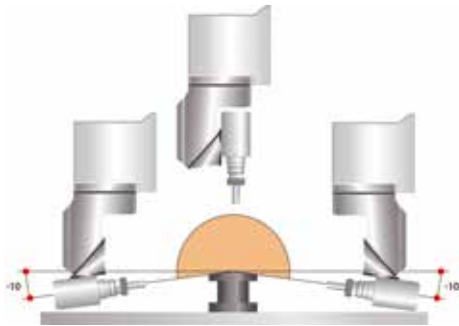

Prisma machining unit geometry allows it to operate at angles of up to 10° below the work piece supporting surface.



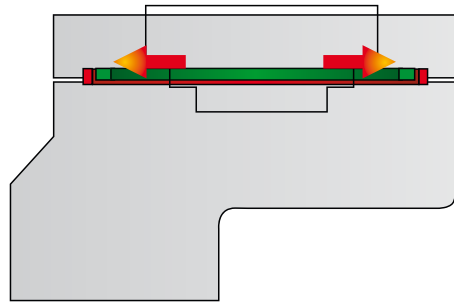
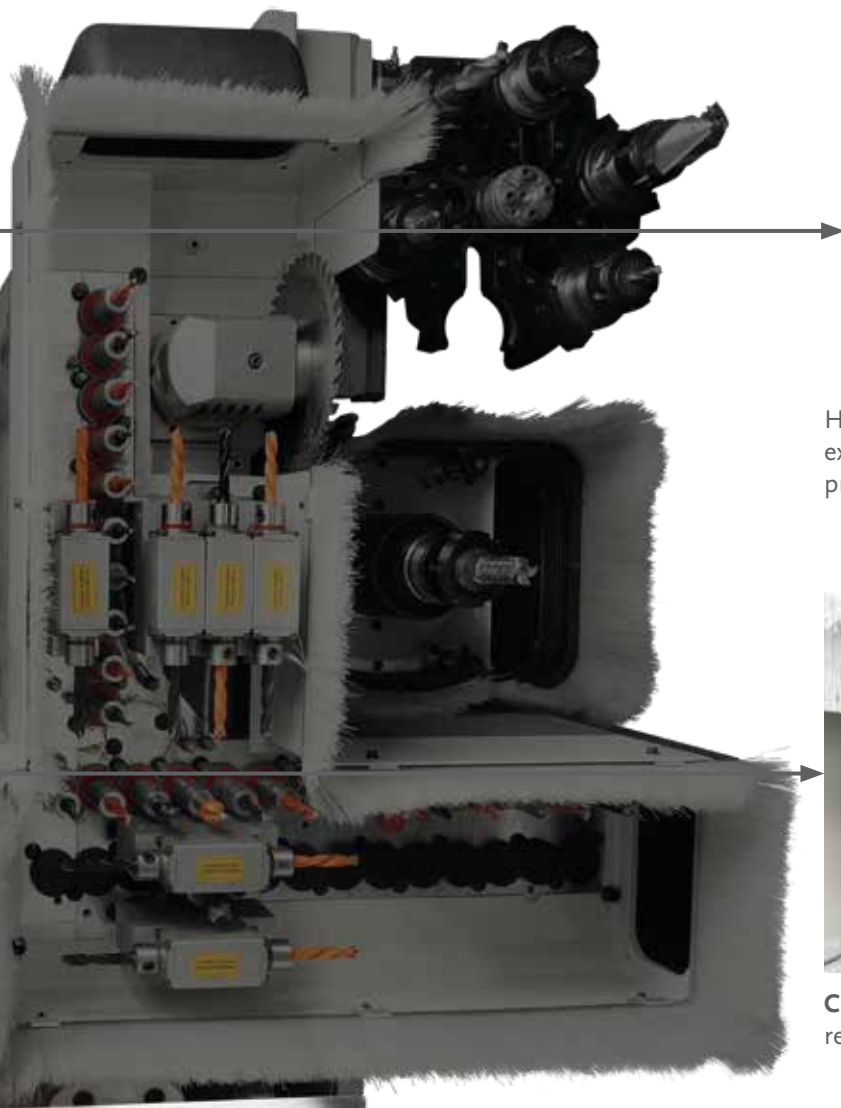

High quality finish even on heavy machining with the exclusive **TTS (Total Torque System) lock system**, that provides the spindle with the stiffness of a 3-axes unit.



**Clean working environment** with the conveyor facilitating removal of shavings and sawdust produced by machining.



# morbidelli m600/800

machining unit: **drilling unit**

The higher drilling capacity in its category with 38 independent vertical spindles and 12 horizontal spindles, complete with blade unit and additional routing unit.

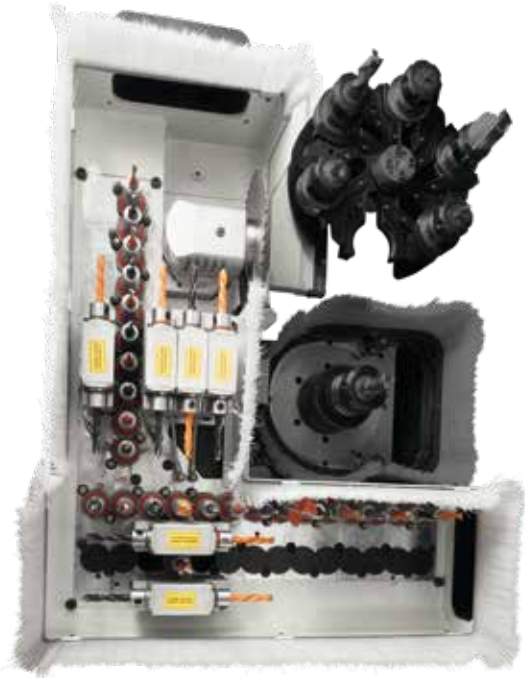

## INDESTRUCTIBLE AND WITH LOW MAINTENANCE

The sturdiness of drilling heads is proven by the reduced maintenance costs: it is recommended only after more than 1000 hours of work.



## THE PERFECT DRILLING: RO.AX SPINDLE

Zero play during machining with the new RO.AX technology (Rotoaxial spindle technology), the most efficient spindle on the market with rotation speeds up to 8000 rpm.





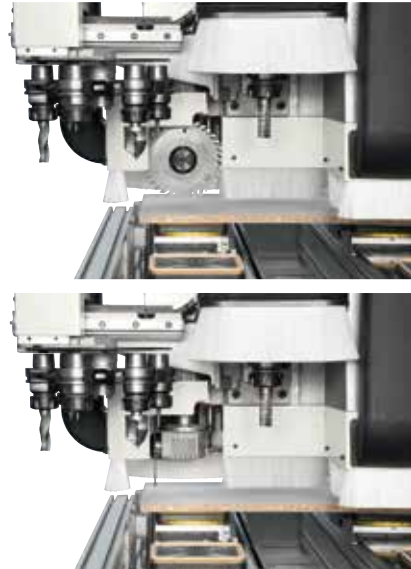
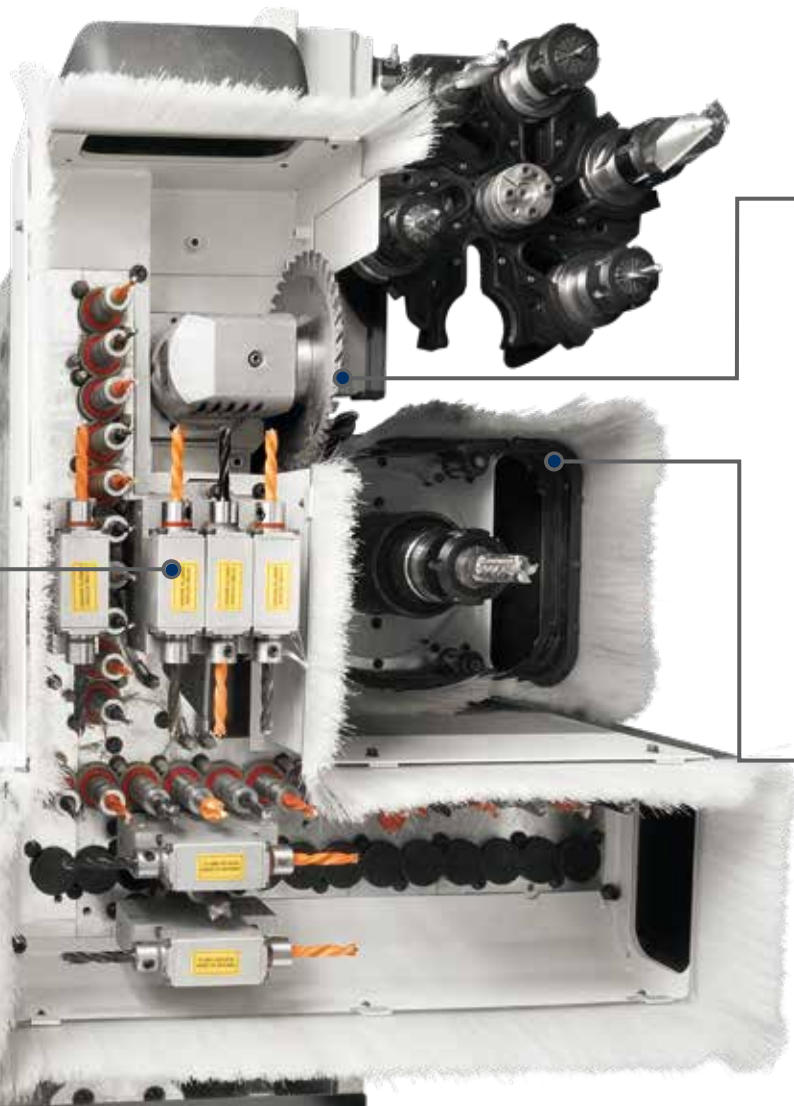

Easy grooves machining on the sides of the furniture thanks to the integrated blade unit with 0-90° rotation.



Higher efficiency and working time reduction with the additional routing unit (PBTC) with 12 kW electrospindle and Rapid 6-position tool changer to carry out the tool change in masked time.



# morbidelli m600/800

## tool changers

Wide range of tools available to the operator with the rear **RAPID** 16 or 24 positions tool changer.



No idle time for the tool change from a machining process to another one with the **RAPID 12 "on board"** fitted directly on the machining unit.

**TR** side tool changer with 10 or 12 positions.



# morbidelli m600/800

machine management



## Console with integrated PC “eye-M”

Industrial PC with multi-touch colour display, 21,5” screen size, Full HD, positioned on a support base with displacement wheels, for an easy handling of the mobile console along the machine perimeter.



## “ALL” AT YOUR FINGERTIPS: TECPAD CONTROL

Management of machine controls with the 7” colour remote control with touch-screen function that facilitates and speed up the setting operations.

# morbidelli m600/800

bars work tables



## SET UP TIMES IN MASKED TIME: TV MATIC WORK TABLE

Work table with automatic simultaneous positioning of bars and pods or clamps. The requested configuration is performed in just a few seconds with a guaranteed safety against the risks of collision between tool and work table.



Simple and quick substitution of pods or clamps through the exclusive rapid docking device.

From a single panel can be obtained more elements and automatically re-position them to carry out all machining without interrupting the production cycle; at the end the work pieces are returned to the initial position to facilitate the unloading from the work table.



Easy positioning of heavy work pieces and large panels with the lifting support.

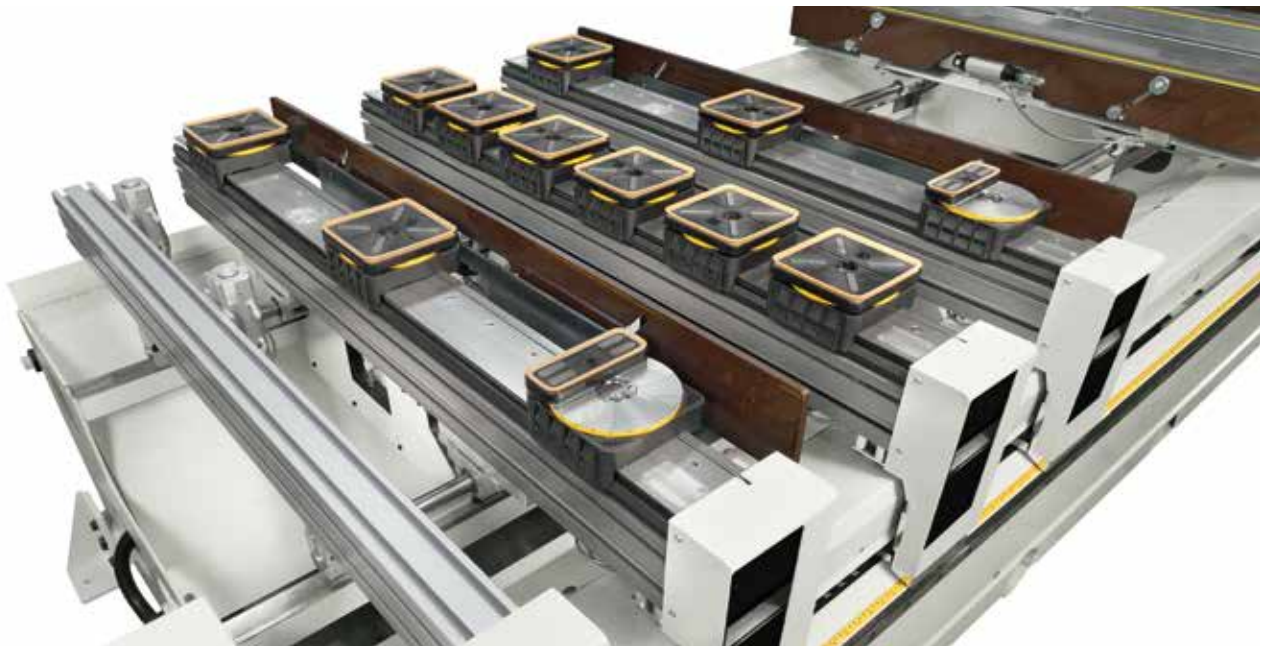

**TOTAL CUSTOMISATION: TV FLEXMATIC WORK TABLE**

This automatic table allows the management of a variable number of pods on the bar, according to the dimensions and shape of the work piece to be machined, in order to always have the best holding without risks of collision. Available also with manual version (TV FLEX).

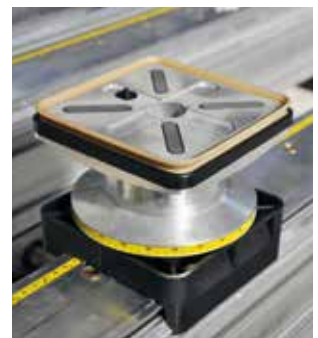

It is possible to position directly on each bar all necessary pods and clamps to lock the work pieces of any shape and dimension.

Wide range of accessories, with variable height from 50 to 110 mm, to satisfy all machining necessities and available for all work tables.



# morbidelli m600/800

multi-function work table

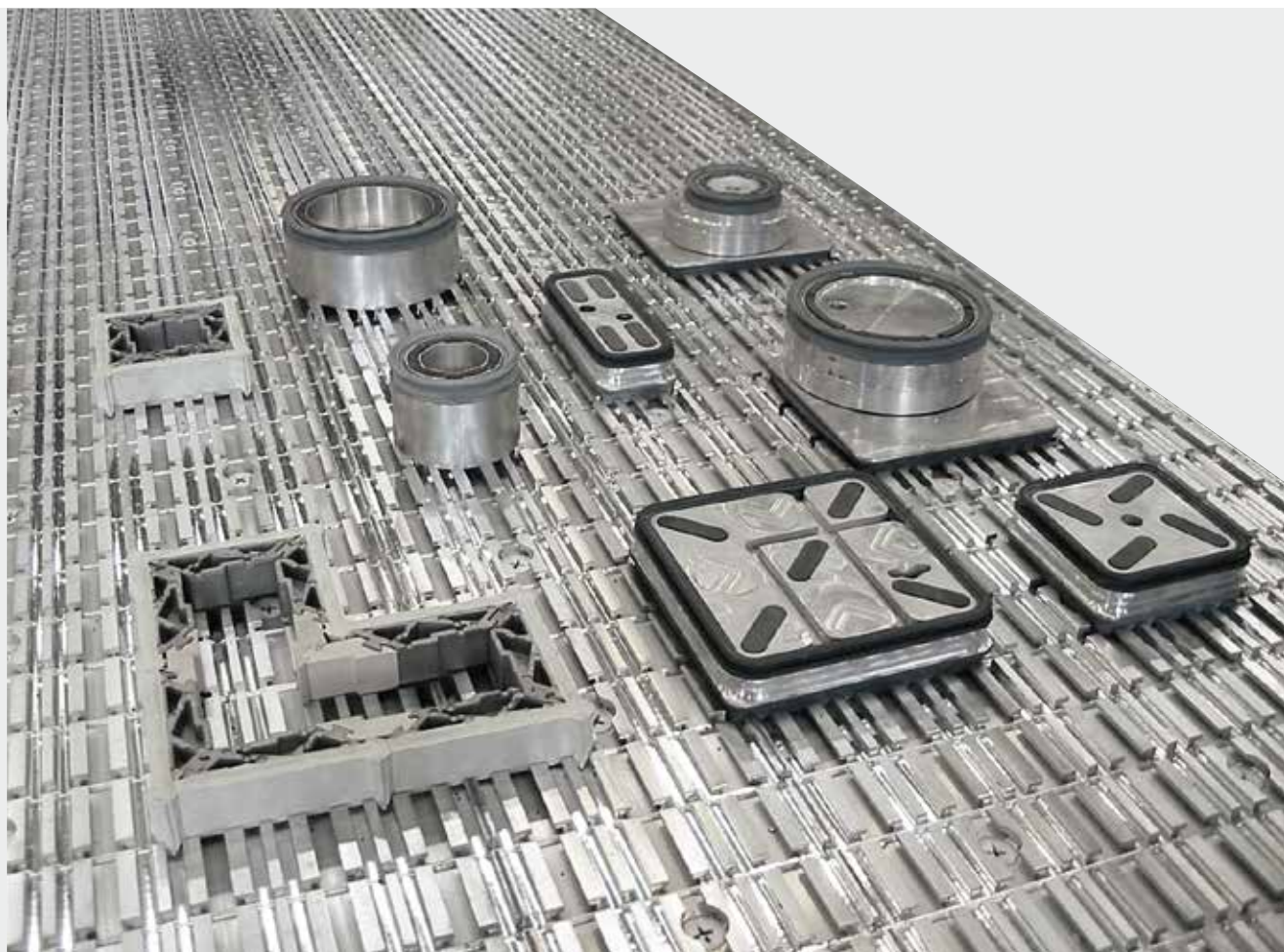

## **VERY HIGH FLEXIBILITY: MULTI-FUNCTION WORK TABLE**

Extremely stiff work table made of extruded aluminium, designed to maintain a perfect planarity over time, even after repeated mechanical stresses. It is ideal also for nesting machining.



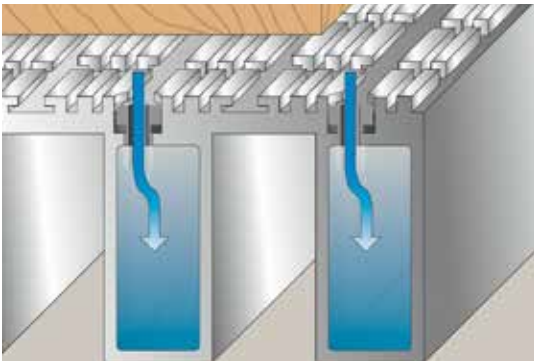

Optimal work piece holding with the high capacity vacuum up to 1000 m<sup>3</sup>/h.

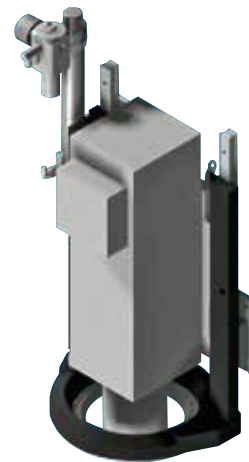

Possibility to work small work pieces with the coaxial mechanical presser.



It is possible to fix custom references thanks to the exclusive "T-shaped" grooves available on the work table. Easy and quick positioning of locking accessories such as MPS pods and the practical MODULSET system with the surface channels structure.

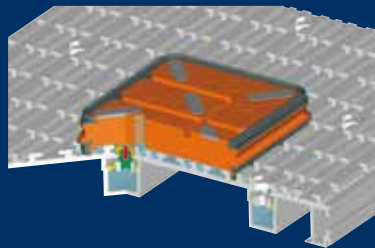

# morbidelli m600/800

loading/unloading automation



Precise and rapid panels positioning on the work table with a dedicated suction cups system.

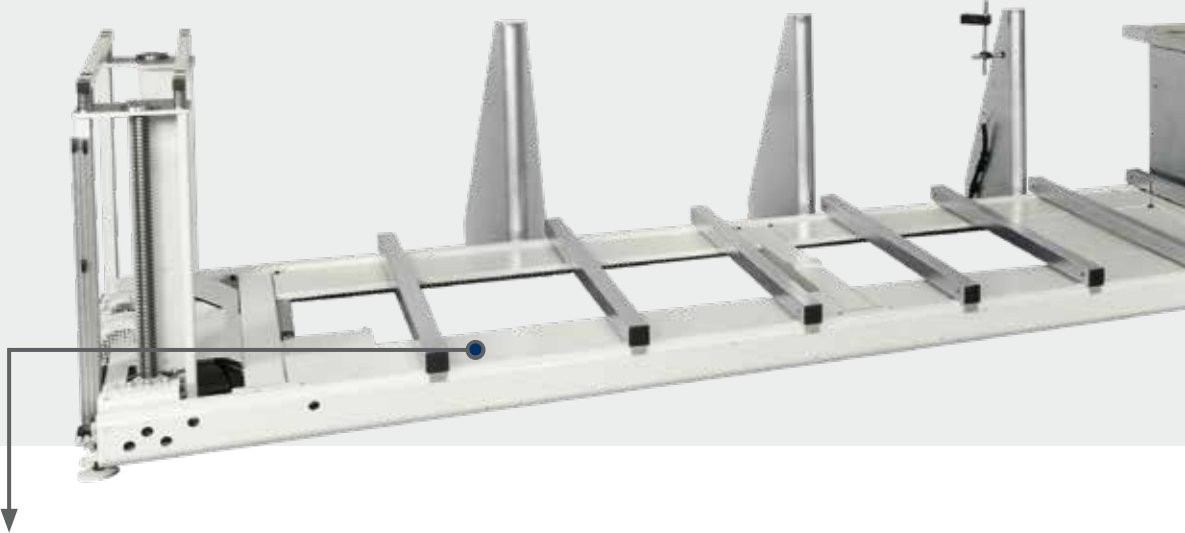

Lifting table for the management of panels stacks with height up to 700 mm.

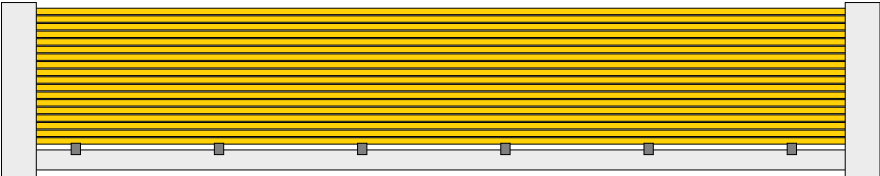



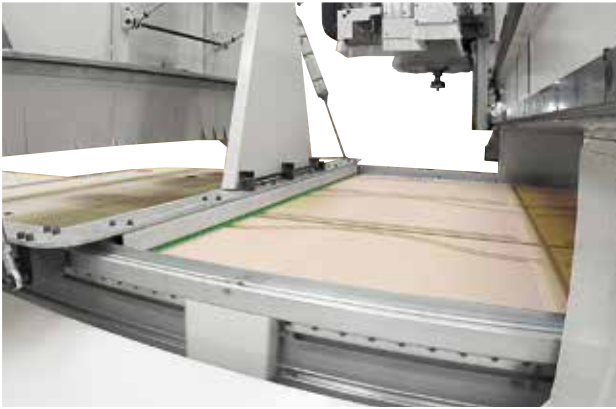

**100% productivity** with the pusher that moves the processed work pieces on the unloading belt and simultaneously cleans the work table while the new panel to be machined is loaded.

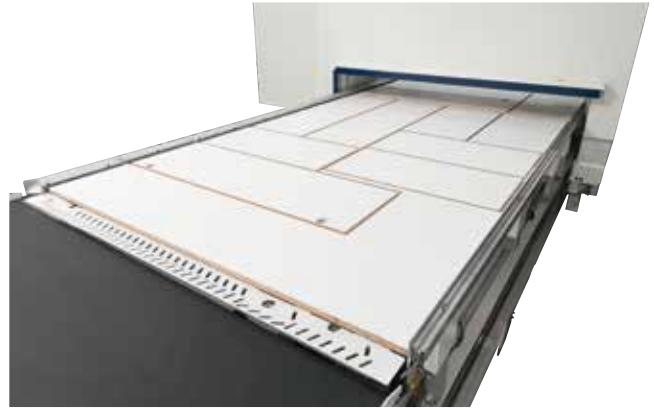

**Perfect work pieces holding at outfeed** thanks to the guides positioned on the sides that drive the panels avoiding any possibility of falling off. The chips conveying device positioned between the work table and the unloading belt maintain a clean environment.



**No dust** with the upper extraction system with the work pieces cleaning and chips conveying system at the end of the belt in order to eliminate any machining waste.

# morbidelli m600/800

loading/unloading automation

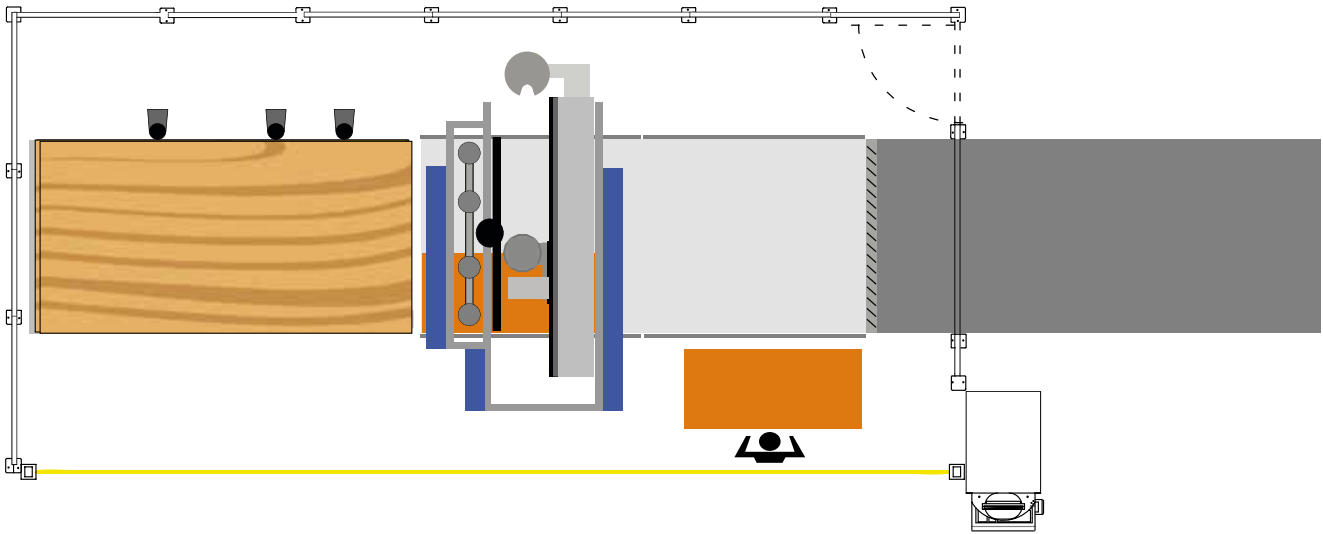

Total flexibility, the cell can be also used with a “stand-alone” machining centre. The photo-bumpers safety system and the split guides allow the manual panels loading/unloading and the pendulum process to maximize the productivity.

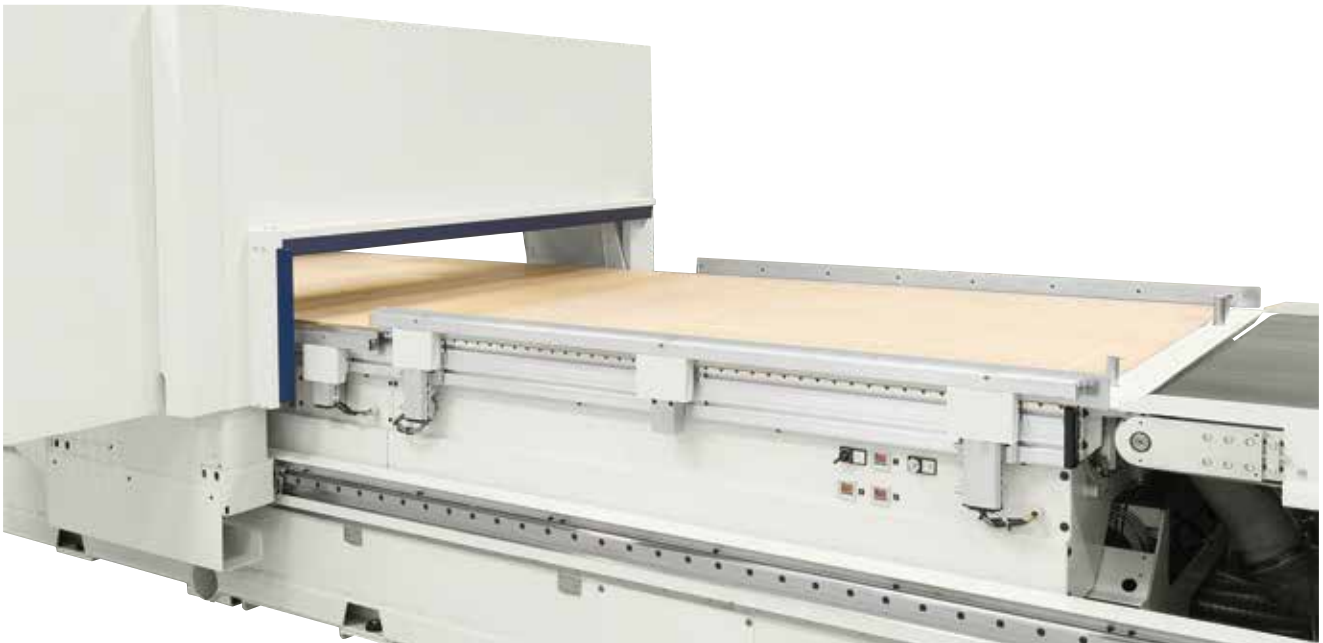

For a higher productivity, in case the material and the machining allows it, the suction cup loading device can position two overlapping panels on the work table.

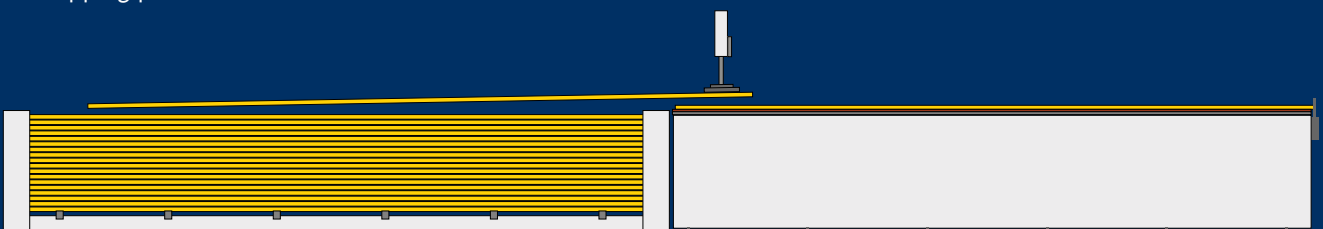

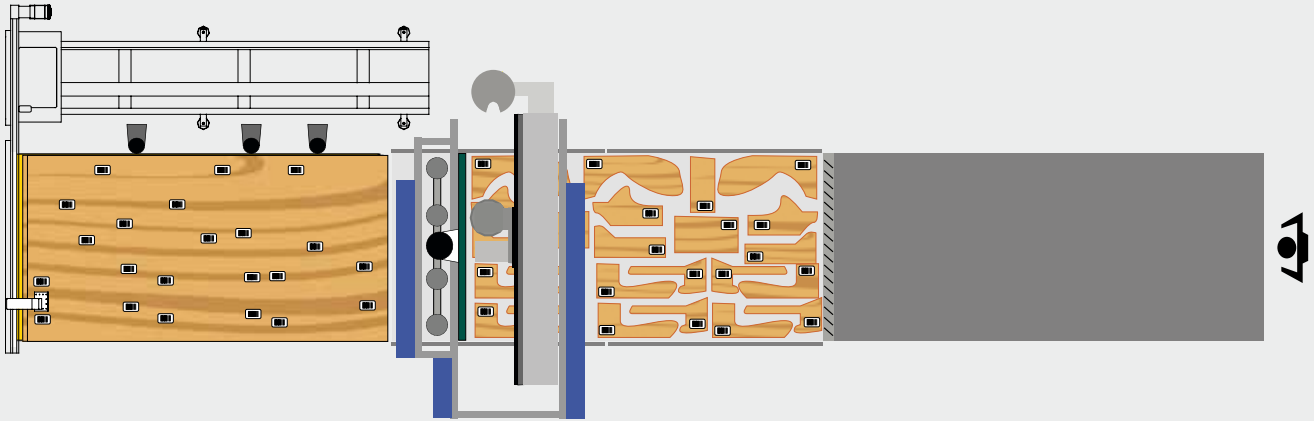

### Work pieces labelling

Complete work cycle with the possibility to automatically apply the labels, in masked time, on the infeed panel before the machining.

It is also available the station for the manual labels positioning on the machined panel at the end of the unloading belt.

## MORBIDELLI M600

### OVERALL DIMENSIONS

		A	B	C	D
<b>MORBIDELLI M600F LOADING/UNLOADING AUTOMATION</b>					
Working area 3650 x 1600	mm	2900	6000 ÷ 6230	10480	13180
Working area 3650 x 2120	mm	2900	6500 ÷ 6710	10480	13180
Working area 4970 x 2120	mm	2900	6500 ÷ 6710	12300	15240
<b>MORBIDELLI M600F UNLOADING AUTOMATION</b>					
Working area 3650 x 1600	mm	2900	6000 ÷ 6230	7640	10500
Working area 3650 x 2120	mm	2900	6500 ÷ 6710	7640	10500
Working area 4970 x 2120	mm	2900	6500 ÷ 6710	9000	11840

## LOADING/UNLOADING AUTOMATION

### LAYOUT

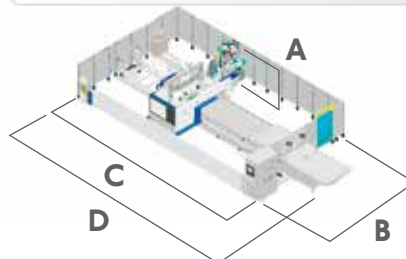

## UNLOADING AUTOMATION

### LAYOUT

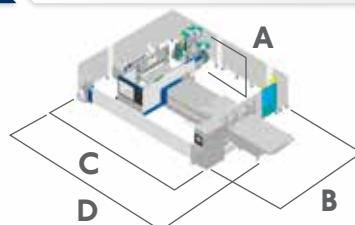

# morbidelli m600/800

other devices

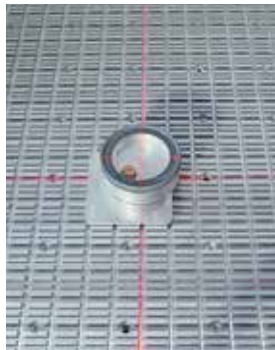
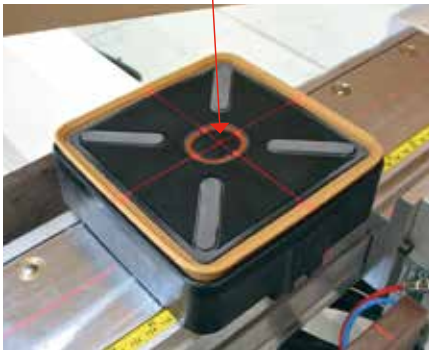

The precision of the pods positioning is ensured by the laser device which allows the visualisation of the precise locking point.



Perfect machining depth even on panels with irregular thickness thanks to the **SYNCRON** electronic system that detects the work piece surface and automatically adapts the Z axis height maintaining the tool position when processing.



**Automatic centralised lubrication** managed by the control.



**Telesolve**  
Teleservice system to connect the machine's PC to the service department via internet.

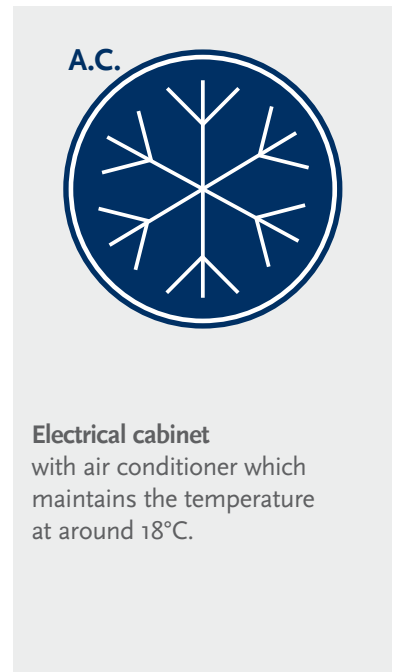

**Electrical cabinet** with air conditioner which maintains the temperature at around 18°C.

## DEVICES FOR PARTICULAR APPLICATIONS

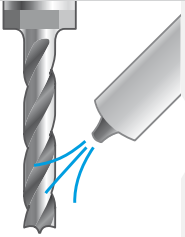

**Air blower on electrospindle**  
For generic applications.

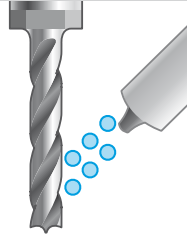

**Ionized air blower on electrospindle**  
It is suitable to eliminate the electrostatic charges due to the cut material, making easier the shavings suction (advisable for plastic materials machining).



**Air blower with microlubrication**  
Air blower with very little oil quantity for the tool lubrication and cooling when used on coated panels.



**Guides protections, X-Y axes**  
By means of dedicated cleaning and protection system, it allows the machining also on abrasive materials (this device is compulsory for machining on plasterboard material).



# morbidelli m600/800

## safety systems

### TOTAL FREEDOM AND HIGH PRODUCTIVITY: PRO-SPEED PROTECTIONS

Protection system for the machine use to the maximum speed of 90 m/min.

When the operator enters into the loading area, which is delimited by the front photocell barrier, the machine automatically reduces the speed to 25 m/min; when the operator leaves the loading area the system restore the maximum working speed.

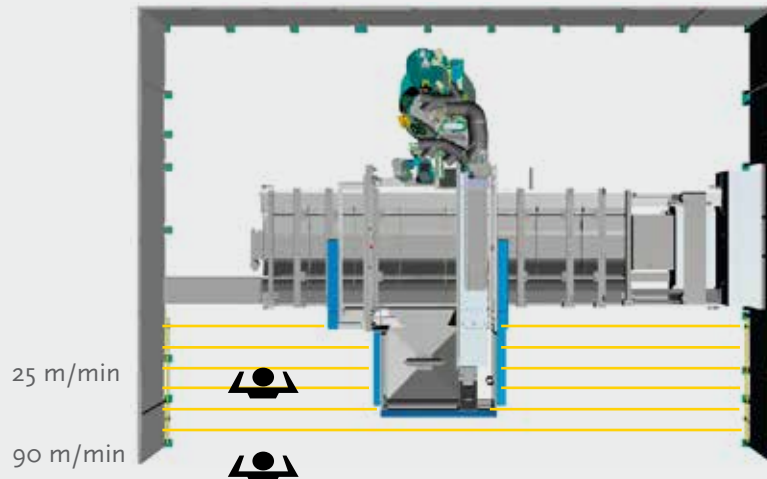

### MINIMUM OVERALL DIMENSIONS AND MAXIMUM SAFETY: PRO-SPACE PROTECTIONS

Loading zone completely free to reduce the space occupied to the minimum.

The protections allow the machine to be used with a feed speed up to 25 m/min.



### GUARANTEED SAFETY: BUMPERS PROTECTIONS

Fully safe machining with the bumpers safety system with lock the machine in case of accidental contact with the operator.

**MORBIDELLI M600 / M800**
**OVERALL DIMENSIONS**

		A	B		C
			PRO-SPEED	PRO-SPACE	
<b>MORBIDELLI M600 / M800 BARS WORK TABLE</b>					
Working area 3680 x 1680	mm	2900	5330 ÷ 6310	4730 ÷ 5600	7560
Working area 3680 x 1905	mm	2900	5440 ÷ 6355	4730 ÷ 5600	7560
Working area 5020 x 1680	mm	2900	5330 ÷ 6310	4730 ÷ 5600	8900
Working area 5020 x 1905	mm	2900	5440 ÷ 6355	4730 ÷ 5600	8900
Working area 6360 x 1680	mm	2900	5330 ÷ 6310	4730 ÷ 5600	10260
Working area 6360 x 1905	mm	2900	5440 ÷ 6355	4730 ÷ 5600	10260
<b>MORBIDELLI M600F / M800F MULTI-FUNCTION WORK TABLE</b>					
Working area 3650 x 1600	mm	2900	5330 ÷ 6310	4730 ÷ 5600	7560
Working area 3650 x 1840	mm	2900	5440 ÷ 6355	4730 ÷ 5600	7560
Working area 3650 x 2120	mm	2900	5730 ÷ 6500	5030 ÷ 5780	7560
Working area 4970 x 1600	mm	2900	5330 ÷ 6310	4730 ÷ 5600	8900
Working area 4970 x 1840	mm	2900	5440 ÷ 6355	4730 ÷ 5600	8900
Working area 4970 x 2120	mm	2900	5730 ÷ 6500	5030 ÷ 5780	8900
Working area 6170 x 1600	mm	2900	5330 ÷ 6310	4730 ÷ 5600	10260
Working area 6170 x 1840	mm	2900	5440 ÷ 6355	4730 ÷ 5600	10260
Working area 6170 x 2120	mm	2900	5730 ÷ 6500	5030 ÷ 5780	10260

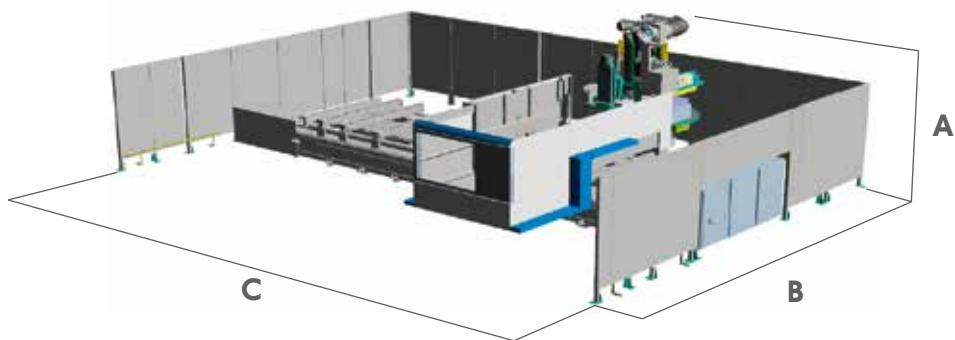
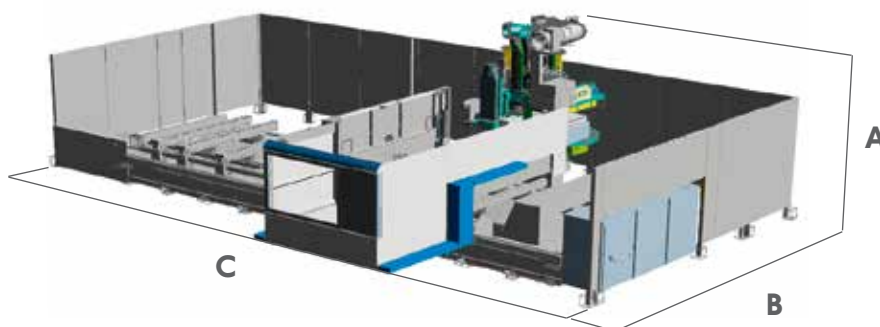
**PRO-SPEED**
**LAYOUT**

**PRO-SPACE**
**LAYOUT**

# M Maestro Digital Systems

SMART SOFTWARE AND DIGITAL SERVICES TO ENHANCE PRODUCTIVITY OF WOODWORKING AND FURNITURE INDUSTRIES.

design



programming  
and data  
generation

Maestro office

Office

Factory

Maestro active

cutting



routing  
drilling

## SOFTWARE

Simple, smart and open Maestro software are tailored on the machine technology as well as on the entire process. All Maestro software share a common mission:

**easy to use**, so that any operator can easily and confidently learn and use the software

**smart**, with algorithms and computing modules aiming at the best possible result

**open in order to integrate** existing software, and provide customer the coverage of all his process.





SCM accompanies woodworking companies throughout their whole process combining machines with matching software solutions and digital services, with a constant strive to enhance company productivity.

The software solutions powered by SCM are developed to optimize machine usage as well as the entire process, providing integration with the different software existing in the company.

## DIGITAL SERVICES

Transforming the way it delivers services to its customers through digital technologies and particularly, the IoT platform that collects and analyses data coming from the machine, **SCM created a world of services enabled by Maestro connect.**

Meaning that connecting an SCM machine through Maestro connect will let customer subscribe a program of fast-evolving services and access a wide range of benefits that even go beyond the machine experience and will support and assist you through the whole life-cycle of your machine.

### Maestro connect IoT Platform

1  
Machine monitoring,  
KPIs, early warning

2  
Maintenance  
equipment

3  
Predictive  
maintenance

4  
Report and historical  
data export to MES

5  
Warranty  
extension

6  
Augmented  
remote support

7  
Smart learning,  
SELF-HEALING,  
video tutorials

8  
Asset management  
with e-shop SCM  
Spare Parts

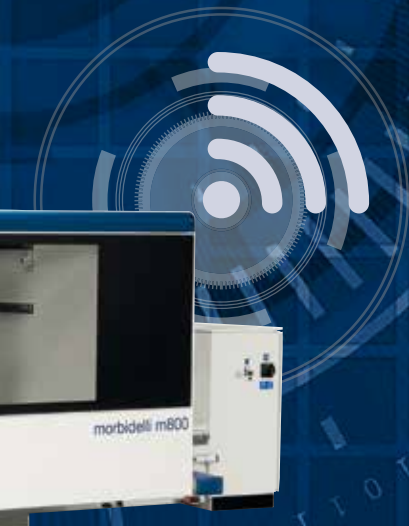



# Maestro cnc

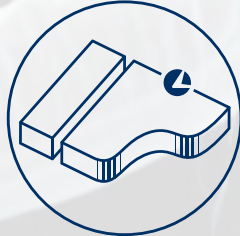

In the office, before the production, the design and programming system Maestro cnc ensures that routing, drilling or sawing can quickly and easily be programmed thanks to 3D graphics of work pieces and machining and clamping aids as well as a smart App and macros library to program any machine operation with a mouse click. Another click away and CNC programs are automatically generated.

## SOFTWARE

### Office

# Maestro cnc

## THE SOFTWARE THAT SIMPLIFIES THE WORK

CAD/CAM programming software to design all the production processes. Developed in Windows® environment it ensures easy programming with an advanced, simple and intuitive sketching environment that features all the tools necessary to design the parts, their layout on the work table, tools management and the relative machining operations. All the procedures are contained in a perfectly integrated and high performance software.

### ADDITIONAL FUNCTIONS



#### Maestro pro view - Unique 3D display

3D Simulator that allows users access to a three dimensional model of their machine in their office and view the operations that will be carried out during the production in advance on their PC.



#### Maestro 3d - Unique in the creation of 3D objects

The module integrated in the Maestro suite is designed to program three dimensional objects on 5-axis machining centres.



#### Maestro apps - Unique know-how

Maestro apps is a library of programming functions that are always available and easy to use, developed by SCM for the production of parts for doors, windows, stairs, furniture and furnishings.



#### Maestro msl connector - Total integration

Connector for third-parties with design software.

### SPECIALISED MACHINING



#### Maestro cabinet - Unique in the creation of furniture

This application is designed for the home and office furniture sector to design furniture and program cabinet production step by step.



#### Maestro nest - Unique nesting process

The module integrated in the Maestro suite provides all the functions necessary to manage the "nesting" process: from a simple "rectangular" piece to the most varied and complex "free form" geometrical shapes.



#### Maestro label - Unique labeling process

Integrated module to manage label's models, which develops labels by inserting texts, images, parameters and the main barcode formats.



# Maestro active cnc

Maestro active is the new operator interface software which has been unified across all SCM technologies. A single operator can easily and confidently run multiple machines due to controller and interface consistency: regardless the machine, Maestro active maintains the same look&feel, with many identical icons and navigation buttons, thus ensuring the same approach to interaction.

## EASE OF USE

The new interface has been specifically designed and optimized for immediate use via touch screen. Graphics have been redesigned for simple and comfortable navigation, with tablet-like icons on touch screen controller.

## “ZERO” ERRORS

Improved productivity thanks to integrated help and recovery procedures that reduce the possibility of error from the operator’s side.

# SOFTWARE

## Factory

# Maestro active cnc

# A REVOLUTIONARY APPROACH TO INTERACT WITH YOUR SCM MACHINE

## FULL CONTROL OF PRODUCTION PERFORMANCES

The creation of customizable reports by operator, shift, program, forecast period (and much more) allows to monitor, optimize and improve the production performance.

## FULL MACHINE AWARENESS AND KNOWLEDGE MANAGEMENT SYSTEM

Maestro active allows to record the times related to setup, maintenance, training and other events, tracing all the activities in a database. The operator’s know-how is also stored and made available to other people inside the organization thanks to the possibility to comment and document all production events or notifications.

## ORGANIZE YOUR PRODUCTION

Maestro active allows to create different users with different roles and authorizations (e.g.: operator, maintainer, administrator, ...). Any user can only execute the functions whose permissions have been assigned to him. It is also possible to define the work shifts on the machine and then detect activities, productivity and events that occurred in each shift.

## TOTAL QUALITY OF THE FINISHED PRODUCT

With Maestro active the quality of the finished piece is no longer put at risk by worn tools. The new Maestro Active Tool Life Determination system sends notification messages as the tool reaches its end of life and recommends its replacement at the most appropriate time.

## TOOLS? NO PROBLEM!

Maestro active guides the operator during the magazine tooling phase, taking into account the programs to be executed.

# A WORLD OF SERVICES FOR GREATER EFFICIENCY

## Maestro connect

### CONNECT YOUR MACHINE AND GAIN ACCESS TO A WORLD OF SERVICES

Connecting your machine through Maestro connect will let you subscribe a program of fastevolving services. You will access a wide range of benefits that even go beyond the machine experience and will support and assist you through the whole life-cycle of your machine.

### FASTER SERVICE INTERVENTION AND PROBLEM RESOLUTION

Maestro connect provides real time data and Health Records of the Machine also to SCM Service drastically reducing its troubleshooting time.

### WORKING ALWAYS IN PERFECT CONDITIONS

Maestro Connect can provide a full kit of sophisticated sensor devices to detect and warn the operator in case of alarming conditions of the machine.

## DIGITAL SERVICES

### SMART MAINTENANCE: DOWN TIME REDUCTION

Maestro connect reduces maintenance downtime thanks to:

- Automatic maintenance notifications and scheduling, to prevent failures and work in the best conditions of use
- Direct connection to SCM Service thanks to an automatic ticket opening function

### SMART MACHINE: ANYTIME, ANYWHERE AWARENESS

Connecting your SCM machine also means having your machine always at hand. Immediate instant notifications in case of alarms or downtimes allow customers to immediately take an action thus optimizing his productivity.

### SMART MANAGEMENT: PRODUCTION PERFORMANCE OPTIMIZATION

Reports and KPIs allow further analysis thus increasing Customer Knowledge about his performance and results.

### SMART PARTS: FAST PARTS REPLENISHMENT

Repairs are scheduled proactively since the system provides Spare Parts suggestions and a direct Integration with Smart Parts e-shop.

### SMART LEARNING: EXECUTE WORK AND RECEIVE PROBLEM SOLVING SUPPORT

Maestro connect provides an intuitive Problem Solving Management System to help the operator to self solve any issue..

### SMARTECH: FASTER AUGMENTED SUPPORT

Maestro connect allows augmented reality support by means of Smartech: the head-wearable computers with wireless connectivity that will bring the interaction between customer and SCM service to a higher level.

### SMART WARRANTY: YOUR MACHINE ALWAYS IN PERFECT CONDITIONS

Together with scheduled maintenance contracts, you can take care of your asset by doubling the warranty from 1 year to 2 years\* for complete peace of mind!

*\* please read the complete contract to understand terms and conditions.*

# morbidelli m600/800

## MORBIDELLI M600 / M800

## TECHNICAL DATA

MORBIDELLI		M600	M800
<b>AXES</b>			
Vectorial speed X-Y axes	m/min	127	127
Z axis speed	m/min	30	30
Z axis panel passage	mm	250	350
<b>ROUTING UNIT</b>			
Motor power (max.)	kW (hp)	17 (23)	17 (23)
Rotation speed (max.)	rpm	24000	24000
Available tools on tool changer (max.)	places	54	54
<b>DRILLING UNIT</b>			
Independent vertical spindles (max.)	n.	38	38
Independent horizontal spindles (max.)	n.	12	12
Rotation speed (max.)	rpm	8000	8000
Integrated blade in X, diameter	mm	125	125
0-90° integrated blade, diameter	mm	160	160
<b>INSTALLATION</b>			
Exhaust air consumption	m <sup>3</sup> /h	5140	5140
Exhaust air speed	m/sec	25	25
Exhaust outlet diameter	mm	250+100	250+100



### LOWER CONSUMPTION = LOWER COSTS

SavEnergy allows **the use of power only when it is required**, making things operate only when they are really necessary.

It means the machine automatically enters "stand-by" mode when there are no panels to be machined.

**COMPANY WITH  
QUALITY SYSTEM  
CERTIFIED BY DNV GL  
= ISO 9001 =**

*The technical data can vary according to the requested machine composition. In this catalogue, machines are shown with options. The company reserves the right to modify technical specifications without prior notice; the modifications do not influence the safety foreseen by the CE Norms.*

Maximum noise levels measured according to the operating conditions established by EN 1870-13:2007+A1:2009:  
Acoustic pressure in process (routing) 81 dbA (measured according to EN ISO 11202:2010, uncertainty K = 4 dB)  
Acoustic power in process (routing) 98 dbA measured according to EN ISO 3746:2010, uncertainty K = 4 dB)

Even if there is a correlation between above mentioned "conventional" noise emission values and average levels of personal exposure over eight hours of operators, these last also depend on the real operating conditions, duration of exposure, acoustic conditions of the working environment and presence of further noise sources, this means the number of machines and other adjacent processes.

# PROMPT AND EXPERT TECHNICAL SUPPORT THROUGH A NETWORK OF 1000 TECHNICIANS AND AN INVENTORY OF 36,000 SPARE PARTS.

HIGHLY SPECIALISED TECHNICIANS, EFFICIENT MANAGEMENT AND 6 SPARE PARTS BRANCHES AROUND THE WORLD GUARANTEE A CLOSE, SAFE AND EFFECTIVE TECHNICAL SUPPORT.

## SERVICE

SCM provides a service that goes beyond the purchase, to guarantee the long term performance of your technological production system and peace of mind for your business.

### A COMPLETE RANGE OF AFTER-SALES SERVICES

- installation and start-up of machines, cells, lines and systems
- tailored training programs
- telephone support to reduce times and costs when machines are not working
- preventive maintenance programs to guarantee long term performance
- complete renovation of machines and plants to renew the added value of the investments
- custom upgrading to update machines and plants and meet new production requirements

## SPARE PARTS

SCM Group can count on 140 spare parts professionals worldwide to meet any request with real time shipments.



### 36,000 SPARE PARTS

Our spare parts inventory, with a value of 12 million euros, covers every single machine



### SPARE PARTS GUARANTEED

We guarantee also hard to find parts, with 3,5 million euros invested in "critical" spare parts.



### IMMEDIATE AVAILABILITY

Over 90% of orders received are carried out the same day thanks to the huge inventory available.



### 6 BRANCHES AROUND THE WORLD

The spare parts service can count on worldwide support (Rimini, Singapore, Shenzhen, Moscow, Atlanta, São Bento do Sul)



### 500 SHIPMENTS A DAY



# THE STRONGEST WOOD TECHNOLOGIES ARE IN OUR DNA

## SCM. A HERITAGE OF SKILLS IN A UNIQUE BRAND

Over 65 years of success gives SCM the centre stage in woodworking technology. This heritage results from bringing together the best know-how in machining and systems for wood-based manufacturing. SCM is present all over the world, brought to you by the widest distribution network in the industry.

**65** years history

**3** main production sites in Italy

**300.000** square metres of production space

**20.000** machines manufactured per year

**90%** export

**20** foreign branches

**400** agents and dealers

**500** support technicians

**500** registered patents

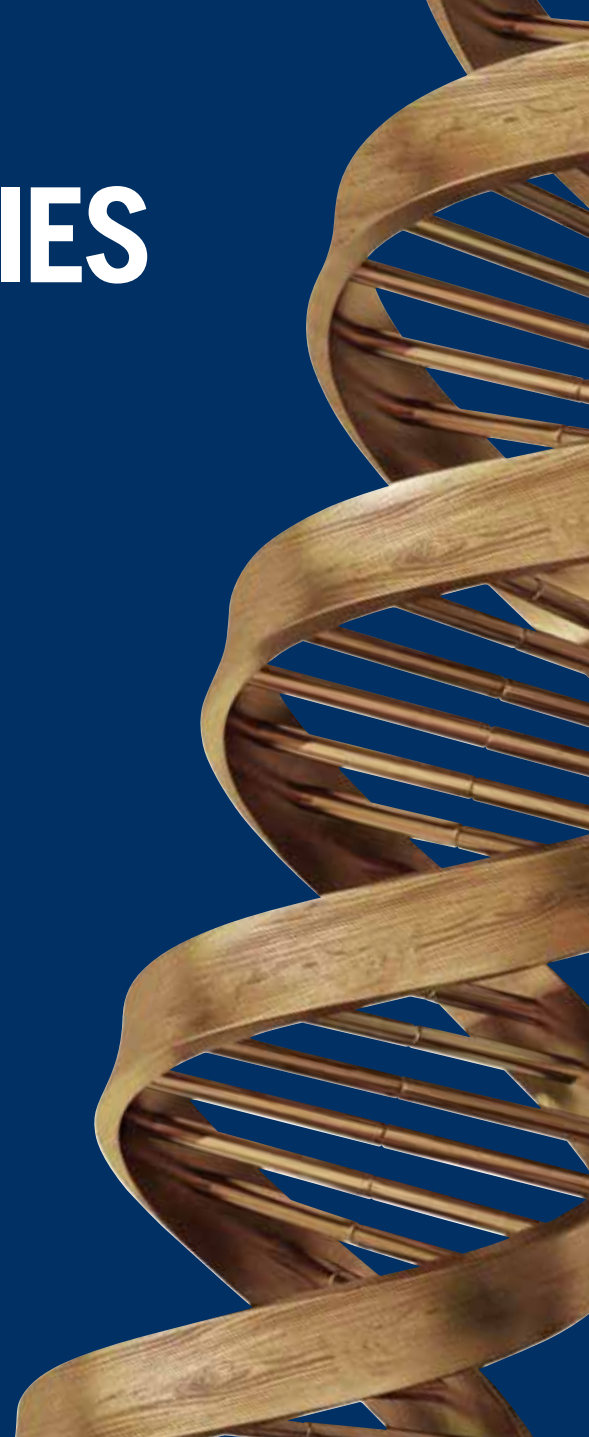

In SCM's DNA also strength and solidity of a great Group. The SCM Group is a world leader, manufacturing industrial equipment and components for machining the widest range of materials.

## SCM GROUP, A HIGHLY SKILLED TEAM EXPERT IN INDUSTRIAL MACHINES AND COMPONENTS

### INDUSTRIAL MACHINERY

Stand-alone machines, integrated systems and services dedicated to processing a wide range of materials.



WOODWORKING TECHNOLOGIES



TECHNOLOGIES FOR PROCESSING COMPOSITE MATERIALS, ALUMINIUM, PLASTIC, GLASS, STONE, METAL

### INDUSTRIAL COMPONENTS

Technological components for the Group's machines and systems, for those of third-parties and the machinery industry.



SPINDLES AND TECHNOLOGICAL COMPONENTS



ELECTRIC PANELS



METALWORK



CAST IRON



*is more*



**SCM GROUP SPA**

via Casale 450 - 47826 Villa Verucchio, Rimini - Italy  
tel. +39 0541 674111 - fax +39 0541 674274  
morbidelli@scmgroup.com  
www.scmwood.com



00L0367198D